

CircuPool® CORE™

Saltwater Chlorination System - Installation and Operation Guide



Models: **CORE15** **CORE35** **CORE55**

CORE-SERIES Salt Systems

Advanced Swimming Pool Sanitation

TABLE OF CONTENTS

IMPORTANT SAFETY INSTRUCTIONS	3
INTRODUCTION & GETTING STARTED	4
SYSTEM OVERVIEW	5
WATER CHEMISTRY & SALT LEVELS	6
Preparing the Pool Water	6
Ideal Salt Level & Pool Size	6
Adding Salt	7
Ideal Water Chemistry Levels	8
OPERATION	9
How it Works	9
Initial Start Up	9
General Operation	9
Using the Control Module	10
MAINTENANCE	11
Expected Maintenance	11
Cleaning the Electrolytic Cell	11
General Maintenance	12
INSTALLATION	13
Overview	13
Connecting to Plumbing	14
Connecting to Power	15
Installation Checklist	16
HELPFUL HINTS	17
TROUBLESHOOTING	18
WARRANTY	20

IMPORTANT SAFETY INSTRUCTIONS

READ AND FOLLOW ALL INSTRUCTIONS

All electrical work must be performed by a licensed electrician and conform to all national, state, and local codes. Improper use or installation can badly harm the unit and its surroundings. When installing and using electrical equipment, basic safety precautions should always be followed, including the following:

- **DANGER** Disconnect all AC power before installation.
- Device can be connected / disconnected to / from power supply by plug or circuit breaker.
- **WARNING** – to reduce the risk of injury, do not permit children to use this product, unless they are closely supervised at all times.
- Unit must be mounted at a minimum horizontal distance of 5 ft (or more, if local codes require so) from the inside walls of the swimming pool.
- **WARNING – risk of electric shock!** Connect only to a grounding type circuit protected by a ground-fault circuit-interrupter (GFCI) outlet. The installer should provide this GFCI requirement. The GFCI should be rated for minimum 6 Amps and tested on a regular basis by pushing the test button. If the GFCI fails to operate correctly, there is ground current flowing indicating the possibility of electric shock. Do not use this unit. Disconnect unit and have a qualified professional fix the problem before operating again.
- **DANGER - Risk of electric shock!** Install at least 5 feet from all metal surfaces. As an alternative, this unit may be installed within 5 feet of metal surfaces, if each metal surface is permanently connected by a minimum No. 8 AWG solid copper conductor to the wire connector on the terminal box that is provided for this purpose.
- **WARNING!** To reduce the risk of electric shock, DO NOT turn on or operate the unit if the cell housing is damaged or improperly assembled!
- **WARNING!** To reduce the risk of electric shock, replace a damaged cord immediately. **WARNING - RISK OF ELECTRIC SHOCK!**
- **WARNING!** To reduce the risk of electric shock, do not use an extension cord to connect the unit to electric power supply; provide a properly located outlet. Do not bury cord!
- Wiring of the unit must be performed according to the wiring instructions detailed in this manual.
- Ensure that equipment and materials used in or around the pool and spa are compatible with salt-based sanitation systems. Certain materials may be susceptible to salt and chlorine damage.
- If acid is stored in the machine room, make sure it is properly vented to avoid damage from acid vapors.
- Under no circumstances should the machine room be used to store equipment, furniture, sports gear or any other apparatus that is not related to the pool including spare acid containers. The machine room must be aired and vented prior to working in it.
- Device is suitable for IP66 environment conditions.
- Device is suitable for voltage range of 100-240Vac, 50-60Hzm current rating 4A.
- Device should be installed at maximum operating temperature of 40°C, Pollution Degree 2, Installation Category 2, Altitude up to 2000m, Indoor/Outdoor, Wet locations
- **SAVE THESE INSTRUCTIONS.**



CORE-SERIES Owner's Manual

INTRODUCTION

Congratulations on your recent purchase of a CircuPool CORE Series Electronic Chlorine Generator – the very first “all in one” salt chlorinator. CircuPool’s high performance systems offer escape from the routine of manual pool chlorination and sanitization. The CORE Series uses a very low level of salt in the pool water to continuously create free chlorine, killing bacteria and algae in the water and helping to maintain a sparkling clean pool. Please take a moment to read through the entire manual before installing your new unit. Your generator must be installed and operated as specified.

GETTING STARTED

READ ENTIRE MANUAL FIRST - To ensure consistent & reliable operation, the pool and equipment must be used and maintained as specified. Most issues are easily avoidable with correct maintenance.

Before installation or operation, please take the time to read this entire manual, compare package contents with the parts list, and gather tools required. Improper installation may void the warranty and create unnecessary hazards. This manual contains step-by-step instructions to help ensure that your installation meets the recommended standards. Spending the time to understand your system and its functions will assure successful, trouble-free operation.

As with any electrical device, it is very important that the installation and service of this equipment be performed by a qualified person with the skills and experience required to do it safely and correctly. Improper installation or service can result in severe electrical shock to the installer or user of the equipment or pool. Please choose your installer with great care! Be sure to familiarize yourself with the pool chemistry requirements and maintenance procedures.

Please visit www.circupool.com/help for more information, tips, and troubleshooting assistance.

CORE SYSTEM OVERVIEW

The revolutionarily compact **CORE** system incorporates all of the following in to one user-friendly, integrated design.

Complete System Includes:

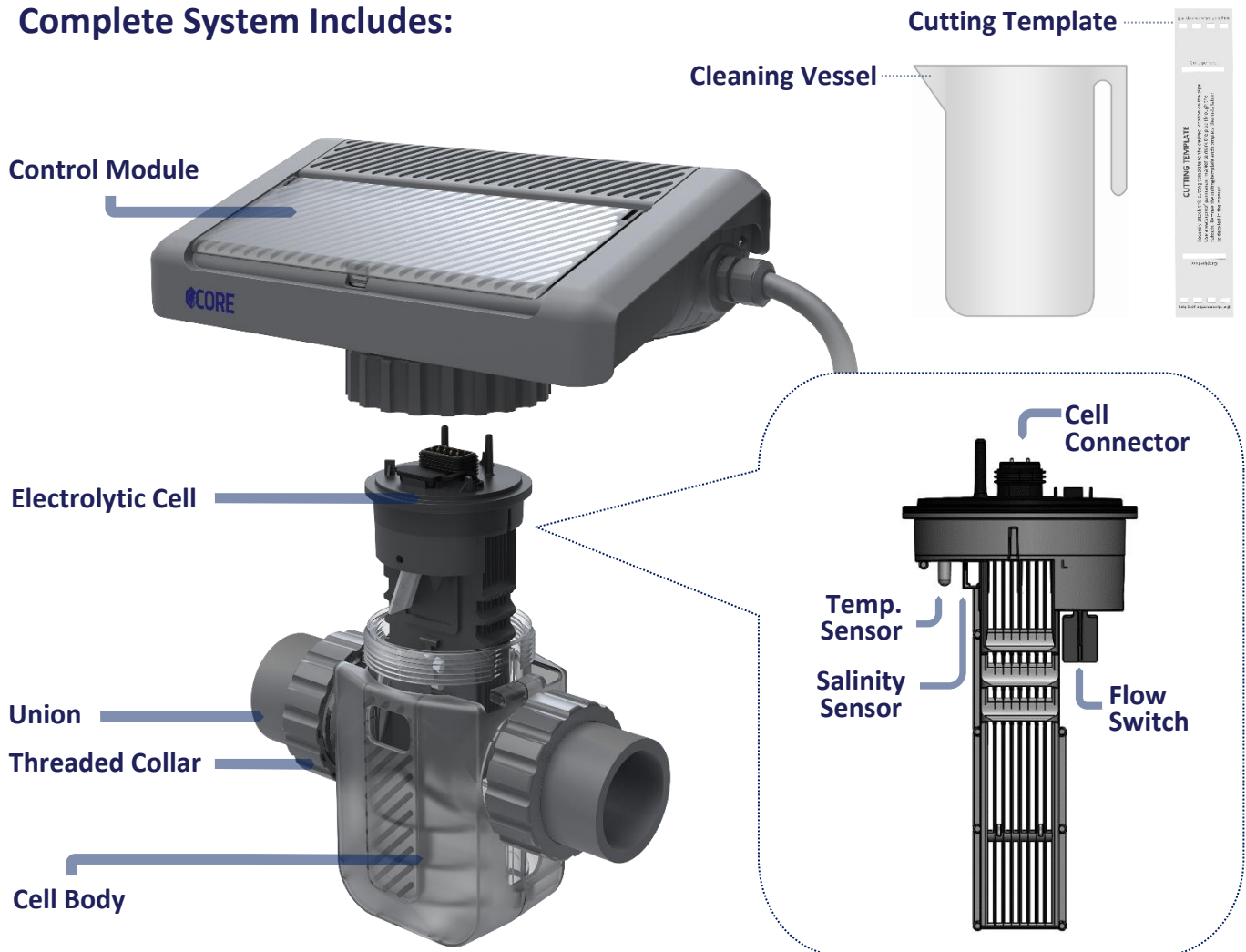

Control Module: This component supplies power to the cell and allows you to customize the system's operation in order to meet your pool's unique needs.

Electrolytic Cell: This component creates chlorine as the water inside passes through and returns to the pool. The Electrolytic Cell ("Cell") contains a bipolar set of titanium plates that use a low level of DC electrical power to generate chlorine from salt in the water.

Salinity / Flow / Temperature Sensor: These components ensure that there is adequate salinity & water flow for the Cell to activate, and monitor the temperature in order to protect the cell.

Cell Body: This component houses the Electrolytic Cell as water passes through inside.

Unions / Threaded Collars: These components allow the Cell Body to connect to the pool's PVC return plumbing.

Cutting Template: This overlay allows you to easily & accurately mark your PVC pipe during installation.

Additional Items Required (Not Included)

PVC Cement, PVC Primer, Hacksaw or Pipe Cutters, Screwdrivers, Permanent Marker

WATER CHEMISTRY & SALT LEVELS

Preparing the Pool Water

It is important that the pool's water chemistry is balanced before the **CORE**-SERIES is powered on and used. In order for the system to be able to work, there must be a minimum level of salt in the pool water, see "Salt Levels" below. In order to achieve normal pool operation, water chemistry needs to be balanced according to the national standards listed under "Ideal Chemistry Levels" on page 8.

DO NOT add chemicals or salt directly to the skimmer. This may damage the cell. If the system has already been installed, it should not be turned on before adding salt. Additionally, leave the salt chlorinator off any time there is a chance of recently added chemicals going through the salt cell in a concentrated form.

For New Pools / Remodels: wait 30 days or longer if specified by your builder for plaster to cure before adding salt.

For Biguanide (Non-Chlorine) Pools: ensure any Biguanide-based chemicals have been removed prior to startup.

Ideal Salt Levels & Pool Size

The ideal salt level for operation is about 3500 ppm (parts per million), and it is suggested to keep the salinity between 3000-4000 ppm. To achieve this level of salinity, use the chart on page 7, which will help you add approximately 30 lbs of salt for every 1000 gallons of water (or 3.6 Kilograms of salt for every 1000 Liters). If you are unsure of the number of gallons in your pool, double-check with the following equations.

Calculating Gallons (Dimensions in Feet)

Rectangular Pool

Pool Width x Pool Length x Average Depth x 7.5 = Pool Gallons

Round Pool

Pool Diameter x Pool Diameter x Average Depth x 5.9 = Pool Gallons

Oval Pool

Pool Width x Pool Length x Average Depth x 6.7 = Pool Gallons

Example – 15' x 30' Rectangular Pool with 3' shallow end and 6' deep end.

15' wide x 30' long x 4.5' Average Depth x 7.5 = 15187 Gallons

Adding Salt

IMPORTANT: Before adding salt at any time, ALWAYS perform an independent water test to measure pre-existing salt levels.

		If the salt level (PPM) in your pool is currently...								
		0	500	1000	1500	2000	2500	3000	3500	4000
If your pool holds this many gallons...	4,000	117	100	83	67	50	33	17	0	OK
	6,000	175	150	125	100	75	50	25	0	OK
	8,000	234	200	167	133	100	67	33	0	OK
	10,000	292	250	209	167	125	83	42	0	OK
	12,000	350	300	250	200	150	100	50	0	OK
	14,000	409	350	292	234	175	117	58	0	OK
	16,000	467	400	334	267	200	133	67	0	OK
	18,000	525	450	375	300	225	150	75	0	OK
	20,000	584	500	417	334	250	167	83	0	OK
	22,000	642	550	459	367	275	183	92	0	OK
	24,000	701	600	500	400	300	200	100	0	OK
	26,000	759	651	542	434	325	217	108	0	OK
	28,000	817	701	584	467	350	234	117	0	OK
	30,000	876	751	626	500	375	250	125	0	OK
	32,000	934	801	667	534	400	267	133	0	OK
	34,000	992	851	709	567	425	284	142	0	OK
	36,000	1051	801	751	600	450	300	150	0	OK
	38,000	1109	951	792	634	475	317	158	0	OK
	40,000	1168	1001	834	667	500	334	167	0	OK
	42,000	1226	1051	876	701	525	350	175	0	OK
44,000	1284	1101	917	734	550	367	183	0	OK	
46,000	1343	1151	959	767	575	384	192	0	OK	
48,000	1401	1201	1001	801	600	400	200	0	OK	
50,000	1460	1251	1043	834	626	417	209	0	OK	

After measuring for any existing salt content in the pool, add salt according to the chart above. The chart allows you to cross-reference your existing salt level and your pool size to estimate the number of pounds of salt required to achieve 3500 ppm. Without the right amount of salt, the result will be reduced efficiency and a low level of chlorine production. In addition, operation at low salt levels will reduce the longevity of the cell.

When adding the salt to the pool, it is best to empty the required salt into the shallow end of the pool and run the filter and pump simultaneously in order to circulate the water and dissolve the salt (the **CORE-Series** is to remain off during this time period). Do not throw the salt bag into the water as chemicals and inks on the bag can interfere with water balance. **Salt may take 24 - 48 hours to dissolve** in summer, and longer in winter. Finer granules of salt will dissolve faster than compressed pellets.

The salt in your pool is constantly recycled and does not normally need to be replenished frequently. The loss of salt throughout the swimming season should be small, and is due primarily to the addition of extra water to replace water lost from splashing, backwashing, and draining. Salt is not lost due to evaporation.

Use only evaporated, granulated, non-iodized salt (Sodium Chloride). The purer the salt (at least 99%), the better the life and performance of the Electrolytic Cell. Water Softener salt (also known as Water Conditioning pellets) is an economical way to buy large quantities of salt. However, only salt that is at least 99% pure NaCl can be used. Pellets are compressed forms of evaporated salt that may take longer to dissolve. Avoid using salt with anti-caking agents (Sodium Ferrocyanide, also known as YPS or Yellow Prussiate of Soda) that could cause discoloration of fittings and surface finishes in pool. Do not use Calcium Chloride as a source of salt. Do not use Rock Salt; insoluble impurities mixed with the rock salt can shorten the life of the unit.

TIP: When adding *large* quantities of salt, independently test existing salt level and add in portions, retesting at each stage.

Ideal Water Chemistry Levels

It is important to maintain these chemistry levels in order to ensure that the pool can be enjoyed safely, to minimize the amount of effort required to sanitize the water, and to prevent corrosion or scaling. The only unique requirement for a pool with a chlorine generator is the low level of salt (salinity) to be maintained in the water. It may be helpful to provide this manual to any pool professional that you may have performing chemical testing or service, as requirements may vary from brand to brand.

	<u>Swimming Pools</u>	<u>Spas</u>
Free Available Chlorine	1.0 - 3.0 ppm	3.0 - 5.0 ppm
Salinity	3000 - 4500 ppm	3000-4500 ppm
pH	7.2 - 7.8 (7.5 Best)	7.2 - 7.8 (7.5 Best)
Total Alkalinity	80 - 120 ppm	80 - 120 ppm
Calcium Hardness	200 - 400 ppm	150 - 450 ppm
Stabilizer (Cyanuric Acid)	30 - 50 ppm	30 - 50 ppm
Saturation Index (LSI)	-0.2 to +0.2 (0 Best)	-0.2 to +0.2
Phosphates & Nitrates	None (0 Best)	None
Metals	None	None
TDS	<1200	<1200

CHEMISTRY TIPS:

Chlorine Stabilizer (Cyanuric Acid)

Stabilizer is needed to maintain proper levels of chlorine; the sun's UV radiation can destroy unstabilized chlorine in as quickly as 2 hours. Stabilizer should not typically be kept above 50 ppm, as excessive amounts can also reduce chlorine effectiveness.

Nitrates and Phosphates

These chemicals are very common and can cause extremely high chlorine demands and can easily deplete your free chlorine levels to zero. Your local pool professional can test for Nitrates and Phosphates, levels should be at zero.

Saturation Index (LSI)

A calculated number used to predict the calcium carbonate stability of water. If the index is higher than +0.2, it can cause quick and excessive calcium scaling on the salt cell. If the index is lower than -0.2, it can cause the water to be corrosive and damaging to metals and minerals in the water, such as the titanium inside the Cell.

Metals

Metals can cause the loss of chlorine. Also, metals can stain your pool and tint your water. Have your local professional test and recommend methods of removal. Be sure to use a phosphate-free metal remover.

Chloramines / Combined Chlorine

Chloramines should not be present in pool water. When organic materials are not fully oxidized by Free Chlorine, Chloramines are formed. This ties up the Free Chlorine in your pool, and does not allow the chlorine in your pool to disinfect. Chloramines also cloud pool water and burn the eyes. Super Chlorinate (shock) to remove Chloramines at the initial startup of the pool.

pH Levels

pH produced by the Electrolytic Cell is close to neutral pH. However, other factors usually cause the pH of the pool water to rise. Therefore the pH in a saltwater pool tends to stabilize at approximately 7.8. This is within national standards. **pH levels above 7.8 drastically reduce the effectiveness of the chlorine**, and can also contribute to excessive mineral scaling. If high, have a pool professional test to see if other factors such as high Calcium Hardness or Total Alkalinity are the cause, and then balance accordingly.

Total Dissolved Solids (TDS)

Adding salt to pool water will raise the TDS level. While this does not adversely affect the pool water chemistry or clarity, the pool professional testing for TDS must be made aware that salt has been added. The individual performing the TDS test will then subtract the salinity level to arrive at the correct TDS level.

OPERATION

How it works

Think of the **CORE-SERIES** as a chlorine generator; set it to create a steady supply of chlorine for the pool, instead of buying and adding chlorine by hand.

How it works: Using electrolysis, it creates chlorine from the salt molecules (NaCl) in your water in order to sanitize your pool. A small electric charge is applied across a set of titanium plates inside the Electrolytic Cell. This produces Sodium Hypochlorite (NaOCl). In water, Sodium Hypochlorite dissociates into sodium (NA+) and hypochlorite (OCl-) ions. It is the hypochlorite ions that form with the hydrogen (H+) ions (from the water) to form hypochlorous acid (HOCl), which is the active agent that destroys bacteria and algae, and oxidizes organic matter. This form of chlorine works quickly in the pipe, leaving only a mild residual in the pool. In addition, the Electrolytic Cell continuously “shocks” the incoming water- burning off any oils, organic matter, or other particles that need to be oxidized. Best of all, the process continuously recycles the salt: after cleaning the pool, the original molecules reform and the whole process begins again. The salt doesn't get used up!

Initial Start Up

Before starting the system for the first time, verify **1) that the pool water is chemically balanced** (see page 8) and **2) that all installation items are completed** (see page 16)

Press the power button on the **CORE** controller while the circulation pump is running. This should activate the system and within moments a green “Output” LED light should flash briefly while the system checks its status (if the pump is not running, you will see the red "No-Flow" light). Once the system is ready to operate, the green “Output” LED will be solid.

Once powered on, you'll want to set its power level (Chlorine Output). To find the optimum Chlorine Output setting, start at a setting of 75% and adjust as needed over the initial start up period. Measure your available chlorine in the pool after two to three days, and adjust the Chlorine Output level accordingly. If the available chlorine is too high, lower the Output level; if the available chlorine is too low, raise the Output level. It will take a few adjustments to find the ideal setting for your pool. Once set for the pool's current needs, it should only take minor adjustments of the system's power level and/or pump run times throughout the season.

General Operation

By familiarizing yourself with the operation of the **CORE-SERIES**, you can achieve the maximum performance for your pool. There are three main factors that you can control which directly impact the resulting free chlorine level in the pool:

- 1) The chosen percentage of Chlorine Output** on the Control Module
- 2) Hours of pump run-time each day**
- 3) Water chemistry balance**





- Including the amount of salt in the pool and chemicals that affect chlorine demand, such as chlorine stabilizer, phosphates, nitrates, and more. See "Ideal Chemistry Levels" on page 8 for more important information.

After making the initial adjustments to your chosen Chlorine Output level, additional adjustments are typically only necessary due to changing seasonal temperatures, or changes in pool use and bather load. Like any pool, ensure that your pump runs long enough for all the pool water to pass through the filter 1.5x to 2x a day (usually at least 8 hours). This amount of time is typically more than sufficient for chlorination of the pool, but if the pool has high chlorine demand, running the pool pump longer allows for more chlorination. Measure your water chemistry and chlorine level on a regular basis.

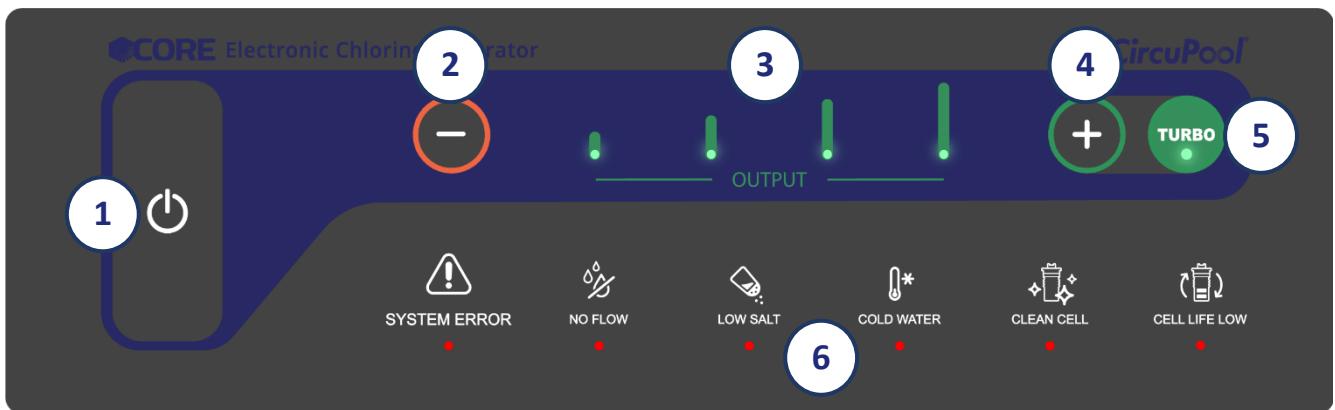
As you use the system throughout the season, **make sure that you clean the Cell as frequently as needed** (see page 11). Once the system detects that the Cell needs to be cleaned, it will display a “Clean Cell” warning light, and then will not be able to effectively create more chlorine until all mineral scaling has been removed from the Cell.

Using the Control Module



- 1) ON/OFF:** Use this button to manually activate / deactivate the system on or off.
- 2) Decrease Chlorine Output:** Use the  button to lower the system's power setting (the rate of chlorine production), in order to customize operation for your pool's needs.
- 3) Chlorine Output Level:** Displays the system's chlorine output level (25%, 50%, 75%, 100%) that you have chosen. The system gradually adjusts its chlorine production. A blinking light indicates the system is making adjustments, a solid light indicates steady operation.
- 4) Increase Chlorine Output:** Use the  button to raise the system's power setting (the rate of chlorine production), in order to customize operation for your pool's needs.
- 5) Turbo:** Press  to temporarily boost Chlorine Output to 100% Maximum Power for 24 hours of actual runtime, after which point it reverts to previously set output level. Press again to cancel the boost.
- 6) System Messages:** These LED lights display important information about the operations of your system.
 -  • **NO FLOW:** When this LED is illuminated, the system has detected an insufficient amount of water in the Cell. This causes the Cell to stop generating chlorine. Verify that you have proper water flow without air bubbles in the Cell housing, and verify that water flow is fully pressing the flow switch away from its resting center position. In case you have a variable speed pump, increase flow until the LED turns off.
 -  • **LOW SALT:** When this LED is illuminated, salt may need to be added to the pool. First, inspect the Cell for mineral scaling and clean if necessary. If this does not solve the problem, manually check the salinity of the pool water and add salt according to the table on page 7.
 -  • **COLD WATER / WINTER MODE:** To protect the Cell, the Control Module is programmed to automatically decrease chlorine production when it senses low temperatures. In case of low water temperature below 64°F the unit reduces chlorine production to 50% and the LED below the 50% bar will be lit. Below 59°F the unit reduces chlorine production to 25% and the LED below the 25% bar will be lit. In both cases, the LED below the required level bar will be blinking and the "Cold Water" warning LED will be illuminated.
 -  • **CLEAN CELL:** When this LED is illuminated, it indicates that the Cell requires cleaning. Refer to page 11 of this manual to see how to clean the blades of the Cell.
 -  • **CELL LIFE LOW:** This LED is illuminated when the Cell is likely reaching the end of its expected lifespan. See "Troubleshooting" section. Replacement cells are available for purchase from your dealer or at circupool.com
 -  • **SYSTEM ERROR:** This LED is illuminated when the system is not able to produce chlorine. Please refer to the "Troubleshooting" section on page 18.

Expected Maintenance

Monitor your pool's salinity level as frequently as you check your other water chemistry levels.

After the system has run for a time, your cell will eventually need to be cleaned due to natural mineral scaling. The system will notify you of this by turning on the "CLEAN CELL" light. When illuminated, follow the cleaning instructions below under "Cleaning the Electrolytic Cell".

The frequency of cleaning depends on your water chemistry and the Saturation Index of the water. For most people, cleaning is only necessary a handful of times per season. More rapid mineral build up is sure sign of a chronically high Saturation Index; it is possible for imbalanced chemistry to cause scaling to occur quite rapidly. Consult a pool professional for additional help.

Cleaning the Electrolytic Cell

Once substantial deposits have built up on the titanium plates in the Cell, the "CLEAN CELL" light will illuminate, and the mineral scaling must be removed. To do so, follow these steps:



Important Precautions: When cleaning the Cell always wear adequate protection, such as rubber gloves and eye protection. Always add acid to water, do not add water to acid. Always work in a well-ventilated area. Splashing or spilling acid can cause severe personal injury and/or property damage.

Caution: Do not insert anything or use metal or other hard objects to clean the cell. This will void the warranty.

Important: Ensure the electrical connector on the top of the Cell does not come in direct contact with water or acid. If this occurs, rinse immediately with freshwater, then rinse with rubbing alcohol and allow to dry thoroughly.

Before removing the Cell for cleaning or replacement:

- 1) Turn off all pool equipment, disconnect unit from power, close supply line valves if applicable.
- 2) Detach unit from the plumbing by unscrewing the Threaded Collars around the PVC unions where the Cell attaches to the return line plumbing.
- 3) Disconnect the Cell from the Control Module by unscrewing the Threaded Collar at the top of the clear Cell Housing. **Place the cap over the electrical connection.** Make sure the electrical connection does not get wet.
- 4) Remove entire Cell from the Cell Housing, then remove the O-ring from the Cell.

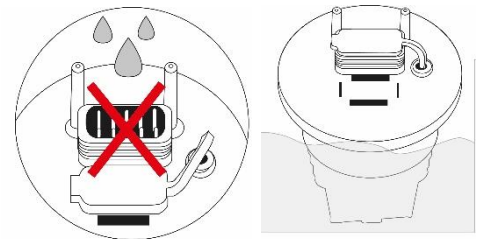

To clean the Cell of mineral buildup:

- 1) In the Cleaning Vessel, mix one part muriatic acid into ten parts water. Ensure that there is enough cleaning solution to cover the Cell blades. Be sure that Cleaning Vessel is stable so as to remain upright and prevent spilling.
- 2) Lower Cell into Cleaning Vessel, ensuring that cleaning solution covers Cell blades.
- 3) Wait for foaming to stop. Allow solution to soak for no more than fifteen minutes.
- 4) Properly dispose of acid solution, and use a hose to generously flush any remaining debris out of the Cell.
- 5) Look inside the cell to check that no debris or scaling remains. Repeat steps 2-4 if necessary.
- 6) Reinstall Cell and Control Module on to return line. Note: The Cell body can only fit in one direction into the Cell Housing, so be gentle and flip the other way if necessary; be sure to remove the cap from the Cell electrical connection.

Note: If mineral build-up is severe, more than one cleaning may be necessary to dissolve remaining solids. Inspect cell plates closely with a bright light after cleaning. If you see any remaining scaling, debris, or physical blockages through Cell, repeat the cleaning process as needed. If "CLEAN CELL" comes back on soon after cleaning, verify salinity and then clean cell again.

General Maintenance

Winterizing

Very little chlorine is necessary at low temperatures. The CORE Series will not produce normal chlorine levels at cold temperatures, see “COLD WATER / WINTER MODE” on page 10. This feature extends the lifespan of the Cell.

If you “close” your pool for the winter, you can continue to follow all standard procedures for your local area.

The Electrolytic Cell will be damaged by freezing water just as your pool plumbing would. In areas which experience severe or extended periods of freezing temperatures, be sure to drain all water from the pump, filter, supply and return lines before any freezing conditions occur. The Control Module is capable of withstanding any winter weather and does not need to be removed.

Spring Start-up

When opening the pool after a period of inactivity, do not power on and use the chlorine generator until the pool's water chemistry has been balanced and brought to ideal levels. Salt must be added if water has been drained over the winter.

Replacing the Cell

When the titanium blades inside the Electrolytic Cell have reached the end of their lifespan, replacements are readily available so that the whole system does not have to be replaced. Replacements are easily switched out. To ensure quality and value, only genuine CircuPool replacement parts may be used.

INSTALLATION

IMPORTANT: If you haven't already done so, it is necessary to balance the pool's water chemistry before the **CORE-SERIES** is powered on and used. See pages 6 - 8 for more information.

The following are instructions for the typical installation using 2" plumbing. If 1.5" plumbing exists, standard reducers can be used to adapt the system; be sure to note the changes to any listed measurements or dimensions that the addition of reducers may cause.

Overview

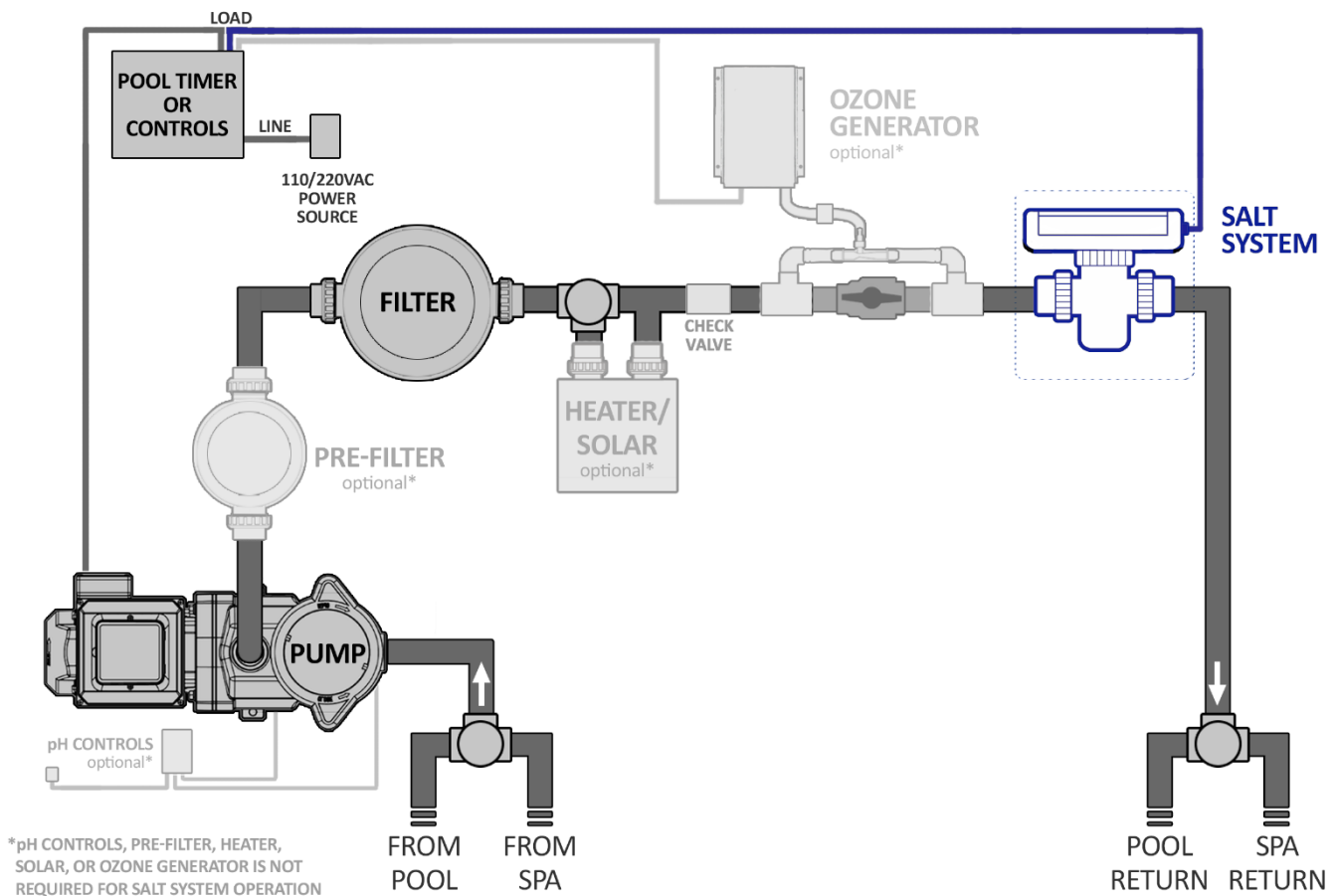

The **CORE-SERIES** consists of one assembly that incorporates all of the following: Control Module, Electrolytic Cell, Flow Switch, and Temperature Sensor.

The system must be installed on the return line as the last pieces of equipment the water passes through before returning to the pool: always after the pump, filter, heater (if applicable), etc. If a heater is present, all equipment must be a minimum distance away, per heater manufacturer recommendations. The system should be installed before any Tees in the return line. Be sure to install the system so that is easily accessible and serviceable. Note that the system's orientation is reversible; it can be installed with water flow passing through it in either direction.

IMPORTANT: Do not block the vents of the unit, located on the rear of the Control Module case.

CAUTION: Ensure that the pool pump and all electrical power are turned off before installation.

TIP: Lay out your equipment and confirm placement and measurements first before cutting and gluing.

TIP: When gluing PVC, parts will slip in place easier once glue is applied. Be sure to apply firm, constant pressure between both glued parts for up to a minute to prevent potential slippage.

Connecting to Plumbing

Note: To ensure that flow switch gets properly triggered, maximize the amount of straight pipe before Cell, at least 6".

1. 11 inches of straight pipe length are required for the installation.
2. On the section of pipe where the cell will be installed, use the Cutting Template to mark two lines 7.5" apart. This is the pipe area that will be removed. (Template is for 2" plumbing only)
3. Cut the pipe at the marked lines using a hacksaw or pipe cutter. Make sure that the cut is parallel and straight.
4. Slip the Threaded collars onto each end of the cut pipe.
5. Clean pipe and inside of Barrel Unions with PVC Primer. Apply glue to cleaned surfaces and slide the Barrel Unions fully onto pipe. Be sure to follow all directions on glue & primer, and wipe any excess glue.
6. After the glue had sufficient drying time, place the system with the o-rings into the opening between the two ends of the pipe and tighten the unions (hand-tight only)

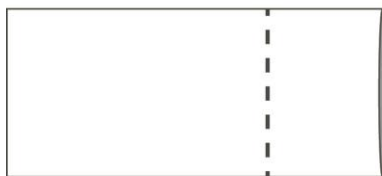
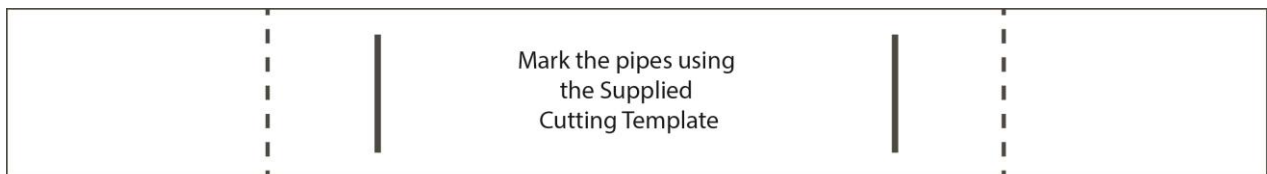

Cut the pipes on the solid line and clean shavings

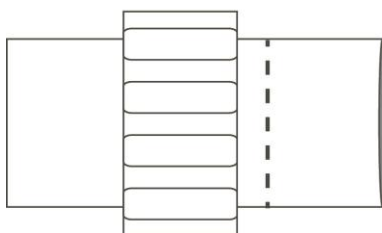
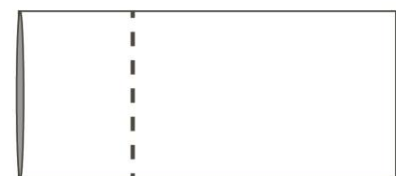

Slide barrel nuts onto pipes
Clean pipe and inner face of the slip connection with PVC cleaning solution

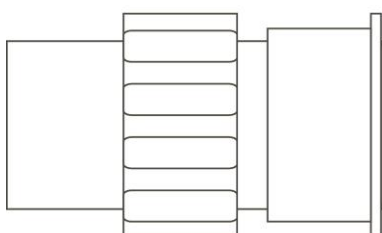
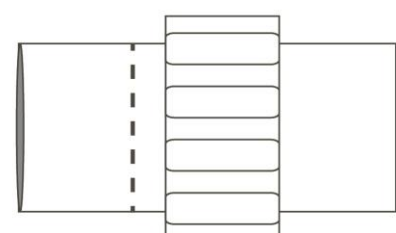

Apply glue to the cleaned surfaces; slide the slip connection over the pipe until the marked line.
Wipe any excessive glue and wait for the glue to cure (minimum 10 minutes).

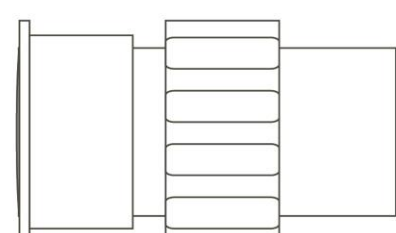

Connecting to Power

CAUTION: Power must be shut off at the circuit breaker before performing any wiring. Be sure to follow local and NEC/CEC electrical codes. It is best that the outlet be wired parallel to the pump so both the unit and pump are working simultaneously. The system has been designed to easily wire into typical in-ground pool systems. To provide safe operation, the unit must be properly grounded. The Control Module uses a switch-mode power supply designed to automatically accept either 120VAC or 220VAC (no internal adjustments are needed).

The CORE Series is shipped from the factory with a power cord that ends in a standard 120VAC plug, to allow the easiest installation. **When used with variable-speed or other electronically controlled pumps,** you may wish to wire the Control Module directly to your power source. This will allow the pump to determine when the Cell is energized or dormant by activation of the Flow Switch.

- A. Simply plug the unit into a ground fault circuit interrupter (GFCI) safety outlet or an outlet protected by a ground fault circuit breaker (GFCB).

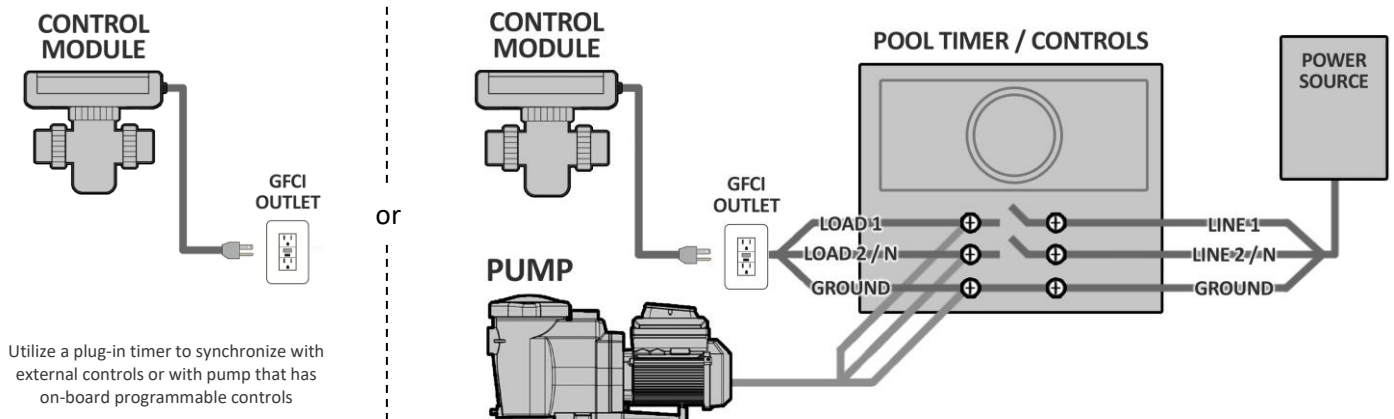

If a hardwire connection is desired, the wiring can be modified by a qualified person.

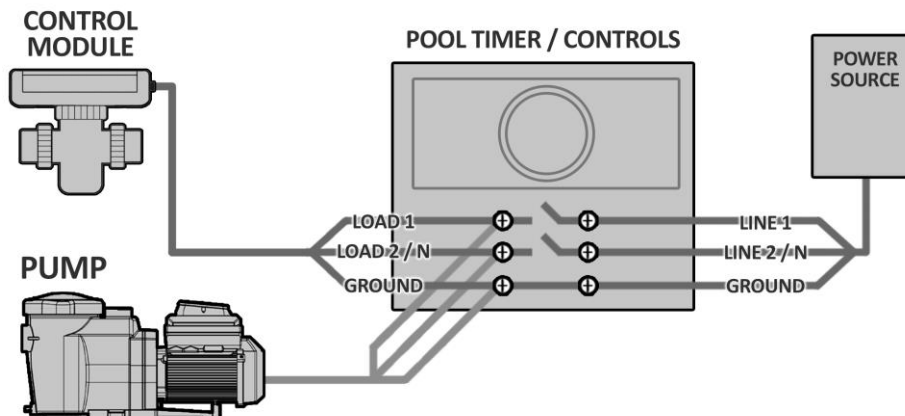

At this point, this installation of your equipment is complete. If the water has not yet been prepared, then you are ready to begin adding salt and balancing your water chemistry, see pages 6-8. Turn the Control Module to the Power Off mode until enough salt has been dissolved in the water.

INSTALLATION CHECKLIST

- Cell Unions installed and glued into pipe work.
- Threaded Collars on either side of the Cell are hand tight.
- Control Module is wired correctly.
- You have checked and confirmed that Control Module switches ON and OFF concurrently with filter pump, or is energized continuously for use with variable speed pump and flow switch is correctly activating Control Module.
- You have checked all connections and joints for leaks.
- Sufficient salt has been added and fully dissolved and circulated throughout pool water.
- Pool has properly balanced water chemistry.

HELPFUL HINTS

For more detailed information and useful tips, visit www.circupool.com/help.

Proper operation of the chlorine generator can be easily verified by checking the lights on the control panel. However, if the pool remains cloudy, or the chlorine residual tests low, then the chlorine being produced is being lost due to high chlorine demand or improper water conditions.

To reduce the chlorine demand, check the pH and Stabilizer (Cyanuric Acid) reading. Check for phosphates and nitrates, which commonly contribute to severe chlorine demand. If tests show correct, then a shock treatment with an oxidizer agent is advised. Generally, superchlorination is not necessary if the pool is maintained at correct levels.

Recommendations and Helpful Hints:

Recommended List

- Read and keep your manual in a safe place.
- Increase Chlorine Production when temperature goes up.
- Increase Chlorine Production when number of guests goes up.
- Use Stabilizer (Cyanuric Acid) to protect free chlorine in pool.
- Mount Control Module in shade or out of the direct sunlight whenever possible.
- Decrease Chlorine Production when temperature goes down.
- Take pool water sample to a Pool Professional at least once per month.

Not Recommended List

- Do not allow fertilizer anywhere near your pool. Fertilizers are one of many sources that contain Nitrates or Phosphates which cause severe chlorine demand in pool water.
- Never use dry acid to adjust pH. A build-up of by-products can damage the Cell.
- Do not add any chemicals (including salt) to the skimmers.
- Do not let salinity level drop below 3000 ppm.

Definitions:

Algae

Plant-like organisms which grow in water. Especially active in summer conditions, where chlorine disinfectant level is too low to destroy them. Algae may be green, brown, pink, or black (Black Spot) in color.

Chlorine Demand

The amount of chlorine that should be added to the water to provide proper bacteria and algae control.

Chlorine Residual

The amount of chlorine left over, after the "demand" has been met.

Combined Chlorine

Weak chlorine which is combined with the contaminants in the water.

Free Chlorine

Active chlorine in the water with the potency to destroy contaminants.

Shock Treatment

The removal by means of oxidation of those materials that have chlorine demand.

Superchlorination

An extra large amount of chlorine added to the water.

TROUBLESHOOTING

For more information or troubleshooting, visit www.circupool.com/help

SCENARIO:	POSSIBLE CAUSE:	SUGGESTED ACTION:
Low or no chlorine residual in pool (Also cloudy water, green pool)	Insufficient Chlorine Output Level	Increase Output Level. This is often required seasonally with increasing temperatures.
	Insufficient run time	Increase run time to at least 1 hour per 10° ambient temp. Ensure 1.5-2x filter turnover.
	Heavy pool use, inclement weather, organic matter	Activate Super CL mode or chemically shock pool.
	Water chemistry issues, such as: Low Chlorine Stabilizer Low salt in pool Phosphates in pool Nitrates in pool	Contact pool professional, ensure all chemicals on page 8 are within range.
	Cell is dirty, clogged, or has excessive scaling or mineral build-up	Remove Cell from plumbing, inspect and clean (see page 11).
	Inactive unit, flow switch not triggered	Inspect Flow Switch, verify sufficient water flow
	Inactive unit, power is off	Turn on system, or see “No Power”
Low or no Chlorine residual in pool after recent installation	Water chemistry was not balanced prior to system installation and a high chlorine demand persists	Contact pool professional, ensure all chemicals on p.6 are within range, chemically shock pool if necessary. Run system at maximum output.
	System hasn't been running	Double check all connections, verify system runs in sync with circulation pump.
No Power	System is turned off	Turn system on, verify circulation pump is active
	Problem with input power, voltage, or configuration of system wiring	Have a professional test input power & ensure correct wiring configuration & connections.
	Reset has tripped	Allow one hour to cool.
	Other malfunction in unit	Contact customer support
Chlorine Output LED blinking	The level has been increased/decreased	This is normal after pressing +/-, or during low temperature
Clean Cell LED is on (Has priority over salinity LED indicators) 	It is time to clean the Electrolytic Cell.	The Cell must be cleaned (see page 11 for instructions).
	Salinity is out of range	Verify salinity (see pages 6-7).
	Cell efficiency has been greatly reduced	Inadequate water flow exists, or Cell must be replaced.
Low Salt LED is on 	Salinity is out of range	Manually verify salinity (see pages 6-7).
	Cell is dirty or clogged	Inspect and clean Cell if necessary.
No Flow LED is on 	Insufficient water flow, low flow rate, or air bubbles	This may happen temporarily if there is air in the lines at initial startup. Check water level, pump cavitation, air or blockages in plumbing, and all valves & seals. Clean filters & strainers.
	Obstruction or build up on or around flow switch paddle	Dismantle Cell and remove debris to ensure flow switch paddle moves freely.

Water leak	O-Ring improperly seated	Ensure O-Rings are clean and in good condition.
	Threaded collars are cross-threaded or pipes are misaligned	Inspect threads for damage, ensure that each screws back on without resistance.
Cell frequently has mineral buildup	This is due to imbalanced water chemistry and a high Saturation Index	Ensure that your Saturation Index is at or near zero, in order to avoid damage or premature cell failure. (page 8)
Cell never or rarely has mineral buildup	Water may be corrosive due to imbalanced water chemistry and a low Saturation Index	Ensure that your Saturation Index is at or near zero, in order to avoid damage or premature cell failure. (page 8)
Cold Water LED is on 	Winter Mode is activated	Water temp is less than 64°. No further action req.
Chlorine Output level does not reach 100%	Cell is dirty or clogged	Clean Cell (see page 11).
	Not enough salt in the water	See Low Salt LED is on
	Low pool water temperature	See Cold Water LED is on
	Overheating protection	In extreme condition, when the unit identifies overheating it will automatically reduce chlorine production to protect itself.
	Worn cell	Clean Cell (see page 11) multiple times to ensure no scale or debris is present, independently verify salinity is in proper range. If problem is not resolved, cell may be worn and requiring replacement.
Cell Life Low LED is on 	The hours of usage the system has tracked indicates that the Cell is likely in the later portion of its typical lifespan. Continue to use Cell until other error LED's are lit and have been troubleshooted.	Replace Cell after "Cell Life" LED is on and other error lights are lit and/or the Chlorine Output setting won't reach 100%. Replacement cells are readily available for purchase from your local dealer or at www.circupool.com
System Error LED is blinking 	Debris is stuck in the electrical connection between Cell and Control Module	Remove Control Module from the Cell. Clean the electrical connection from any debris stuck in it. Wipe with a dry cloth.
	Other communication problem between Cell and Control Module	Contact Customer Support
System Error LED is on 	Debris is stuck in the electrical connection between Cell and Control Module	Remove Control Module from the Cell. Clean the electrical connection from any debris stuck in it. Wipe with a dry cloth.
	Cell blades are dirty or worn	Inspect Cell for debris or scaling, clean if necessary. Replace Cell if damaged or worn.
	Salinity is greatly out of range	Manually verify salinity (see pages 6-7).
	A more serious error has occurred	Contact Customer Support.
	All LED lights flashing	Salt level may be greatly out of range

CIRCUPOOL LIMITED WARRANTY

CircuPool CORE Series Electronic Chlorine Generators carry the following Limited Warranty should failure occur due to faulty manufacture or materials, during normal use and service. For residential use, the manufacturer warrants to the original purchaser that the equipment shall be free of manufacturer's defects at the time of sale, and upon examination shall provide replacement parts in accordance with the following schedule:

Year One -	No charge for parts.	Year Five -	Parts supplied at 80% of base price.
Year Two -	No charge for parts	Year Six -	Parts supplied at 80% of base price.
Year Three -	Parts supplied at 40% of base price.	Year Seven -	Parts supplied at 80% of base price.
Year Four -	Parts supplied at 60% of base price.	Year Eight -	Parts supplied at 80% of base price.

For Commercial use (any pool that is not for private single-family use, or the use of which is subject to regulation), parts are warranted against defect for a period of one year.

This limited warranty is subject to the following terms, conditions, and exclusions:

1. To obtain the benefits of this warranty, contact the warranty department for troubleshooting. You may obtain current contact information at www.circupool.com/help. Warranty claims must be initiated in a timely manner. Upon discovery of a defect, the warranty department will issue a Return Merchandise Authorization (RMA) and defective items and parts are to be shipped by customer to an authorized service representative, freight prepaid.

Upon examination, the determination of the cause of failure shall be made solely by CircuPool Products. The date upon which the claim is submitted, and an RMA is issued shall solely serve to determine at what point the claim falls within the schedule of warranty proration, in comparison with the original purchase date. **No packages will be accepted without a RMA number.**

2. Should a defect in any item or part covered by the warranty become evident during the warranty's term, CircuPool Products will at its sole discretion repair or replace such item or part. CircuPool Products reserves the right to replace defective parts with new or refurbished parts. This warranty does not include the cost of labor or transportation charges for equipment or component parts to or from CircuPool Products, or the removal, reinstallation, or any such costs incurred in obtaining warranty replacements or repair.

3. This warranty extends to the original retail purchaser and original installation site only, beginning at the original date of purchase, and is non-transferrable.

4. The warranty contains the following exclusions. O-Rings, rubber gaskets and seals, electrical fuses, and circuit-breaker components are normal replacement items subject to wear and are excluded from the warranty. Product discoloration, or any other cosmetic or superficial damage or deterioration, regardless of its cause, is not covered by this warranty. The warranty is not applicable to problems arising from circumstances outside the control of CircuPool Products, including, but not limited to the following:

- A. Damage or premature wear due to improper pool chemistry, and failure to maintain pool water chemistry in accordance with the recommendations contained in the owner's manual.
- B. Damage due to improper installation or connection to improper voltages, including materials and workmanship supplied by others.
- C. Damage due to negligence or failure to properly maintain equipment, including operation with insufficient water flow or the maintenance of clean and tight electrical connections.
- D. Damage due to improper service, as well as unauthorized equipment modifications and use of non-genuine replacement parts.
- E. Damage due to misapplication, misuse, abuse, or failure to operate equipment as specified in the owner's manual.
- F. Problems resulting from tampering, accident, fire, flood, freezing, lightning, insects, or other natural elements, or other circumstances beyond the control of CircuPool Products.
- G. Damage due to over-tightening of threaded components or excessive pressure or stress.

The liability of CircuPool Products shall not exceed the repair or replacement of defective items or parts under the referenced limited warranty terms. There are no implied warranties of merchantability or fitness for a particular purpose that apply to this equipment. Under no circumstances shall CircuPool Products, its agents, employees, and affiliates be liable for any loss, damage, injury, inconvenience or loss of time, incidental expenses such as labor and material charges, or any other incidental, or consequential damages, which may result from the use, installation, removal, or reinstallation of its equipment and parts.

This warranty is valid only in the United States of America. This warranty gives you specific legal rights and you may also have other rights, which vary from state to state. This warranty supersedes all previous publications. Any dispute between the original purchaser and CircuPool Products will be settled by binding arbitration, conducted in Harris County, Texas, under the rules of the American Arbitration Association.

CircuPool Products (888)-206-9938 www.circupool.com/help